

NETWORK OF
CONVENIENCE

IDEAL

INSTRUMENTS



AUTOMATED. SAFE. RELIABLE.



CATALOG

2022



URK-800-A



ACP-900

UDR-800



ULM-900

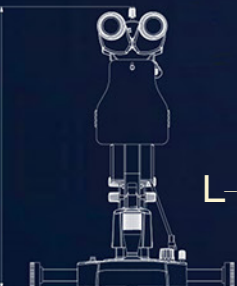

L-0189



Ideal Ophthalmic Devices

Viewlight USA displays a new generation workstation controlled by a user friendly backlight console where all main commands are accessible, fast and comfortable to use.



Refined and Advanced
Performance

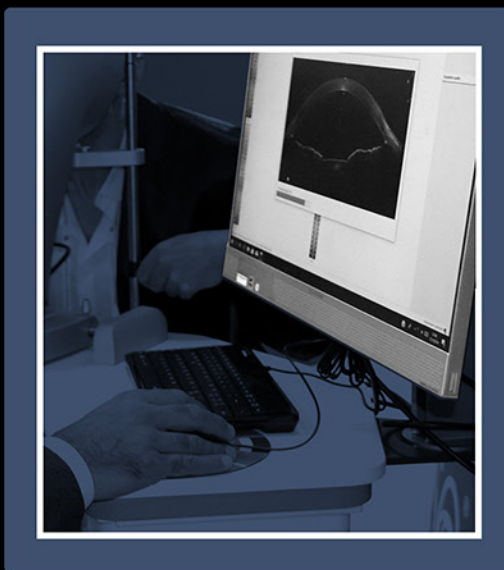

Sophisticated Interface
Diagnostics

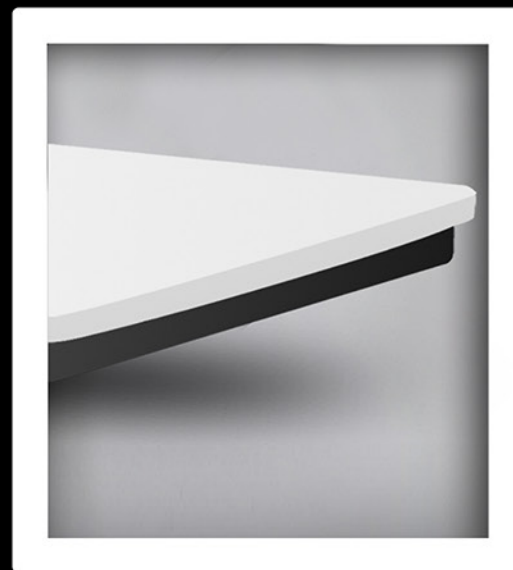

Durable Ophthalmic
Instruments



MADE IN ITALY

REFRACTION UNIT PEAK



Exceptional Results.

Viewlight USA offers the latest ophthalmic examination units designed with a digital touch control panel, LED lamp with projector support, and counter balanced phoropter arm for easy access.



Practicle
N. 2 objects storage



Illumination
LED Overhead light



Console
Design for Easy Access

LUXURIOUS 360° CHAIR

DIMENSIONS

1. Device Light Intensity Adjustment
2. Lamp Light Intensity Adjustment
3. Auxiliary ON / OFF
4. Unit ON / OFF
5. UP / DOWN Chair Movement
6. Anterior / Posterior Base Movement
7. Projector Turn ON / OFF
8. Lock / Unlock Table

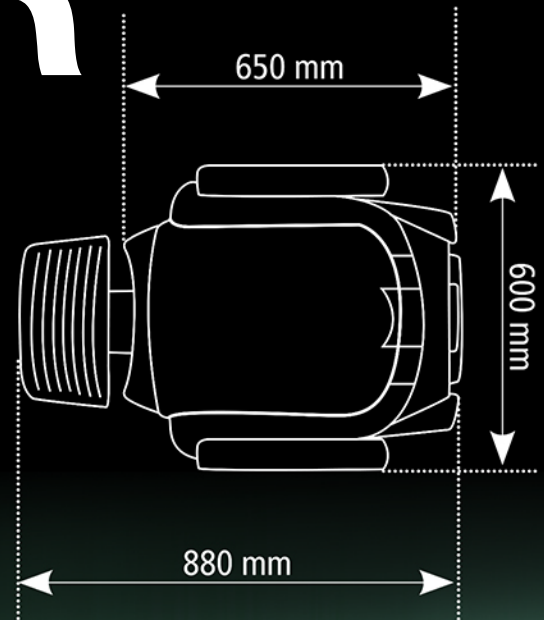

Ergonomic Mobility

HOW COMFORTABLE IS IT?

Viewlight USA displays a NEW modern and advanced examination chair, with detailed adjustable armrests, recline bar for easy rotation, reclinable footrest, and comfortable upholstery padded materials.

DIGITAL PHOROPTER

UDR⁸⁰⁰



1. Horizontal Controller
2. Forehead Prop
3. Face Protector
4. Test Window
5. Lever
6. Near Vision Vision Chart Bar
7. Forehead Fixing Dial VD Control Dial
8. VD Test Window

ACCURATE MEASUREMENTS

New anti-biotic material UDR-800 digital phoropter may judge the abnormal condition of the eye and may give specific figures for prescriptions that subjective refractometry may not be able to offer.

Eco Friendly
Design



Auto - Shielding
Functions

Near Distance Vision
Chart



CONTROLLER

LCD MONITOR

- Monocular PD measurement
- Worldwide various chart support
- High Resolution 8" LCD display
- Embedded printer
- Help and real-time guide function
- Near-distance vision chart
- Vision chart bar - Included
- LCD monitor tilting degree 240°
- Operating test data through jog dial
- Forehead fixing dial VD control dial
- Leveler, horizontal controller
- A/S functions by USB port

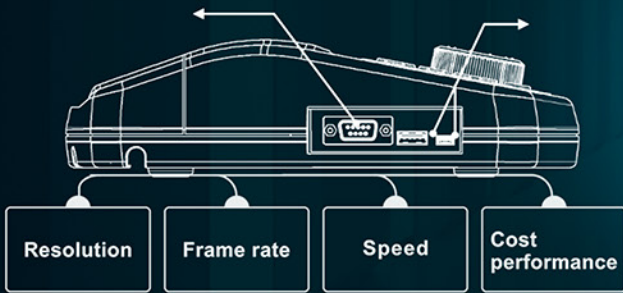

✓ Included with **UDR-800**



Multiple Function
Dials

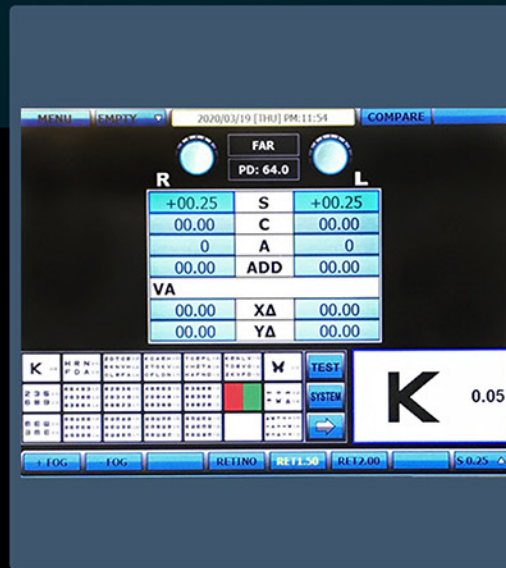

Fast Real-time
Results



Embedded
Printer

DIGITAL SLIT LAMPS

L-0189

Halogen & LED

INAMI quality ophthalmic clinical and digital slit lamps are designed to operate from basic cross angle stereo vision to galilean convergent microscope system and increased magnification levels.

- 1/2.5 inch CMOS
- High definition images and videos

MADE IN JAPAN



LED 5 Magnification
Ratio



Optional Accessories
Not Included



Digital Camera
IMAX 5

DIGITAL LENSMETER

ULM 900



Viewlights new digital lensmeter **ULM-900** has an accurate lens detectors readers with a wide measurements of double (triple) vision lens.



Adjustable 7"
Touch Screen

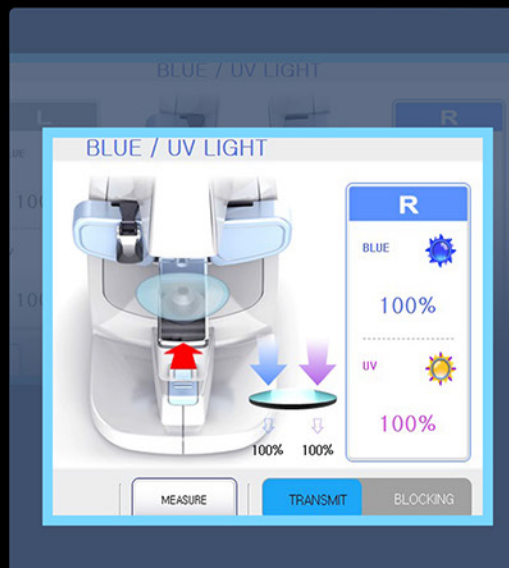

Measurement
Interface



Accurate Lens
Detectors

AUTO REFRACTOR & KERATOMETER

URK^{700-A}

Redefined Optics



The **URK-700A** highlights the benefits of a 7" touch screen monitor, followed by gun-type joystick, chinrest adjuster lever and auto save measurement button.



AUTO REFRACTOR & KERATOMETER

URK 800-A



URK-800-A features an illumination sensor, focusing navigator, multilevel dial types, extremely rapid automatic measurements and accurate data.



Continuous
Observation



Accurate Dioptric
Measurements



High Illumination
System

CHART & PROJECTOR

ACP 900



ACP-900 features 40 different charts including red/green, polarized filters, vertical and single letter mask.

ACP-900 features a wireless control interactive iOS applications managing the functions for the chart system.



24" CHART AND PROJECTOR

ULC 900

Viewlight USA introduces the latest LCD View Charts ULC-900. Displaying a high resolution 24" wide screen and refined digital configurations.

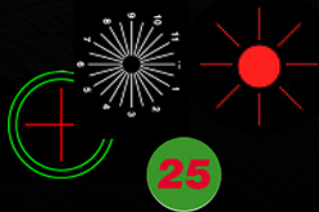
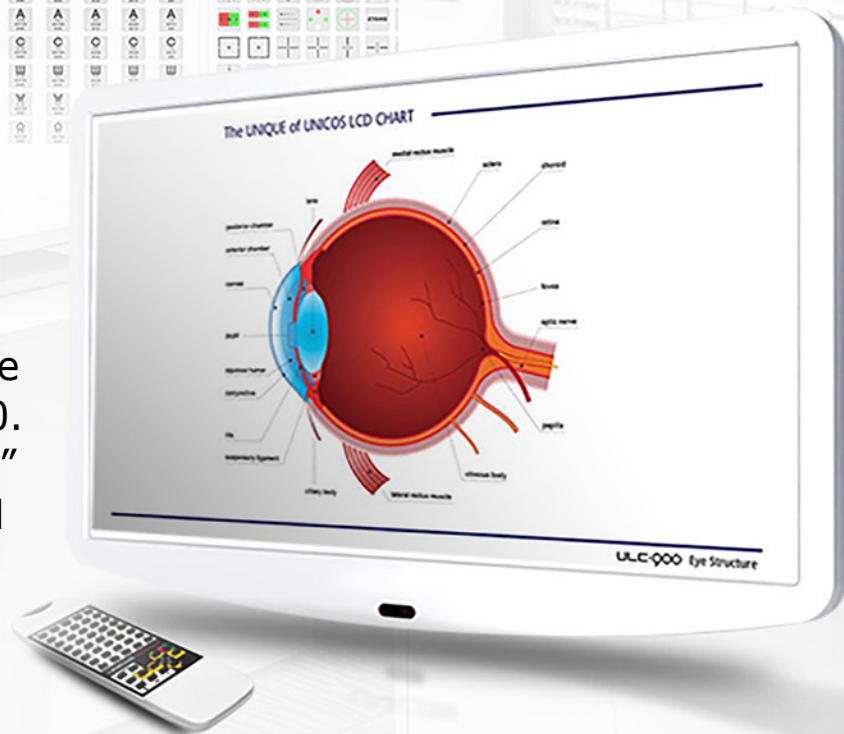

ULC-900 is operated both via automatic wireless or digital settings to provide precise measurements and variable testing examinations.



High Resolution
Wide Screen

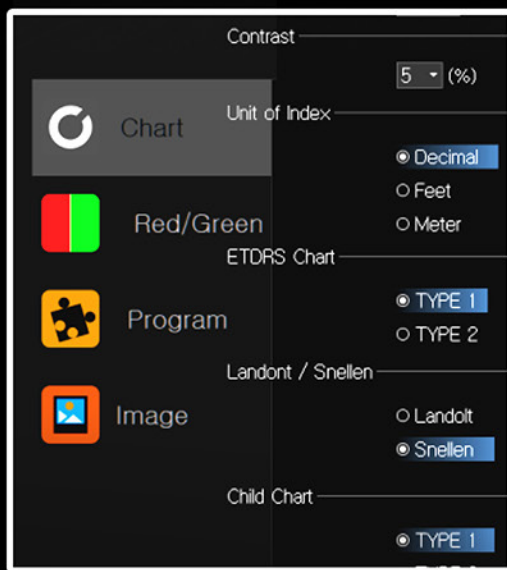

Multiple Test
Programs



High Performance
Polar Filters